



Shipping Dimensions		Width	Depth	Height	Weight
Main Body & Player Console		40" (102cm)	88" (224cm)	88" (224cm)	500# (227 kg)
Bonus Sign		23" (57 cm)	18" (46 cm)	58" (147 cm)	171# (78 kg)
Assembled Dimensions		Width	Depth	Height	
Single Game Assembled		39" (99 cm)	83" (211cm)	82" (208 cm)	
2 Games with Bonus Sign		79" (200 cm)	83" (211cm)	140" (356cm)	

RING TOSS JUNIOR

TABLE OF CONTENTS

INTRODUCTION	3
SAFETY NOTICES	3
INSTALLATION	7
ASSEMBLY	9
CAMERA CALIBRATION	17
INTERNET OPTIONS INSTRUCTIONS	20
MENU OPTIONS	23
MAINTENANCE	29
TROUBLESHOOTING.....	30
EXPLODED DIAGRAMS	33
SCHEMATICS	40
FACTORY WARRANTY	45

INTRODUCTION

RING TOSS JUNIOR is an amusement redemption game where the player tosses rings onto lighted bottles to score points. Further bottle rows are worth more points. A player can win the Progressive Bonus by reaching the required amount of points. Tickets are awarded based on the number of points scored. Rings are dispensed to the player by a hopper. 3 rings are dispensed to the player at a time. When the player picks up the rings from the tray, another 3 rings are dispensed. This 'batch' method will continue until the game is over.

SAFETY NOTICE

This Manual describes how to set up and use this product. It is intended to instruct the owner/operator and qualified maintenance personnel to safely and correctly operate the game. Be sure to follow all the safety and warning instructions described to prevent personal injury and/or damage to the game.

- Before connecting the machine to the main power source, verify that the voltage is correct to avoid fires or electric shock.
- DO NOT touch the plug with damp hands.
- To avoid electric shock and short circuit, DO NOT expose the power cord or ground wire across walkways.
- DO NOT place any flammable objects close to the power cord.
- When plugging/unplugging the power cord, make sure to hold the plug. DO NOT pull on the power cord.
- In the event of a frayed or broken power cord, please contact your dealer for replacement.
- DO NOT use fuses or parts that are not recommended by the manufacturer.
- DO NOT disassemble, change or modify the machine without authorization. Inappropriate handling of the machine may cause damage to the game and injury to players and spectators.

- Please check and maintain the game regularly.
- Standing or climbing on the game is prohibited to avoid injury

RING TRAY WARNING

The working load of the ring tray actuator is 500 pounds in either direction. Therefore, the frame for the tray may damage anything that might be blocking its path on the way up or down. To avoid damage or injury, be certain nothing is blocking its path.

SAFETY INTERLOCK SWITCH

THIS MACHINE IS EQUIPPED WITH THREE (3) SAFETY INTERLOCK SWITCHES TO PREVENT DAMAGE OR INJURY WHEN THE GAME IS OPEN.

DO NOT BYPASS THESE SAFETY FEATURES!!

The switch behind the lower rear door prevents the ring tray from moving when the door is removed.

The switch on the ring hopper assembly, as well as the one underneath the hinged console top, prevent the hopper motor from running when the console is open or not attached to the body.

Make sure all doors are installed and the console top is closed before attempting to play a game, otherwise the game will not work correctly.

The photos on the next pages show the location of the interlock switches.

REAR DOOR SWITCH

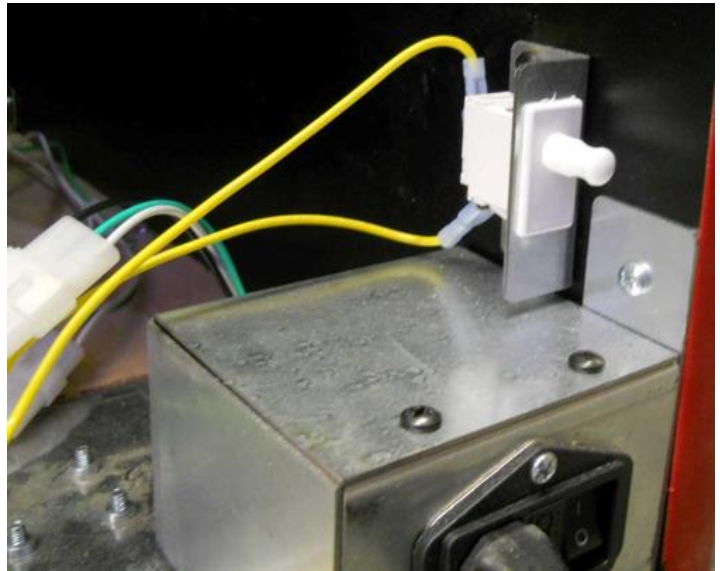

CONSOLE TOP SWITCH



HOPPER ASSEMBLY SWITCH



POWER SOURCE

IMPORTANT!

GAME MUST BE CONNECTED TO A GROUNDED POWER SOURCE.

GAME MUST HAVE GROUND CONNECTION FOR PROPER OPERATION AND USER SAFETY PROTECTION.

DO NOT OPERATE GAME WITH GROUND LEAD CUT OFF POWER CORD.

INSTALLATION

POWER UP:

Upon power being turned on (and computer booting) the game raises the tray table to clear all rings. Calibration of the camera is then performed (the rows with 7 bottles will light white for a few seconds, turn off, then the rows of 6 bottles will light white. Then all will light up in multi-color). Upon successful calibration, the game will then go into attract mode. The boot up and calibration sequence may take up to 60 seconds to complete. **DO NOT TURN OFF POWER DURING THIS SEQUENCE.**

TECHNICAL INFORMATION:

1. The “brains” of the game are a Raspberry Pi v-3 minicomputer nested in a custom I/O board, which controls all lights, motors, and audio. The O/S and game software reside in a micro SD card plugged into the Raspberry Pi. The Pi-I/O board also has its own microprocessor that controls all the multi-color addressable LEDs (see point #4)
2. **The tray table:** Is raised and lowered by an “actuator” (a motor connected to a gear box and vertical worm gear). The motor draws between 4 and 4.4 amperes of current. -- **BEWARE-- the casual working load of the actuator is 500 pounds...in BOTH DIRECTIONS ... the frame for the tray will easily crush, pinch off, break, and otherwise damage anything that might be blocking it’s path on the way down (and up) ... be certain all tools, equipment and bodily extremities are well out of the way ...**
3. **The Hopper:** Rotates in a counter-clock wise direction (viewed from above). The motor draws between 2 and 3 amperes (12v) while running. The hopper motor stops turning when the prescribed number of rings have been dispensed, and/or the front trough sensor (closest to the player) has detected a ring (or any other solid object blocking the beam). If the rings are picked up by the player at the same rate as they are dispensed, the hopper will continue to move. Should the player delay in picking up the rings, the hopper will stop until the player picks up the rings. In diagnostics mode, there is a menu selection to make the hopper run. It will run for the time it takes for 3 rings to be dispensed, then stop.
4. **The lighted bottles;** (33 total in alternating rows of 7 and 6) have serial addressable LED strips inside. The LEDs are fault tolerant, so that if one fails the others “down-stream”

will continue to light. The data comes through a 9-pin Molex connector that leads from the Pi-O board to the 5 rows of bottles. Each row has its own 3-pin connector which provides data, +5 volts, and ground (found on the right inside of the rack when being viewed from the rear). The data is daisy chained (in each row) from the first bottle to the last. Should a bottle become disconnected, the remainder of bottles down the line (in that row) will not light, or not change color. The order of the rows are counted as 1 being the closest to the player, and 5 being the furthest away.

5. **Audio/Video;** Video comes from the HDMI port on the Raspberry Pi. The cable (10 foot long) from Pi to monitor is male HDMI to male DVI. Audio comes from the 3.5mm (1/8 inch) stereo jack on the Pi-I/O board, NOT the Raspberry Pi despite that it has its own jack as well. Volume is adjustable from the menu as well as the volume knob on the amplifier. Typically, the amplifier is set to some fixed point, and volume is adjusted from the menu.
6. **Power;** There are two power supplies for the game. A 12 volt 29-ampere supply, and a 5 volt 100-ampere supply. Both supplies are UL rated and run on 110v or 220v 50/60 Hz mains. However, the operating voltage must be switched manually. The game draws 6.5 amperes (+ or-) from the mains @110 volts. The IEC-power filter/fuse/switch/connector is rated at 10 amps, 250 volts.

For the dual-game configuration (2 games side by side) the left-side game (viewed from front) has an extra power supply providing 5 and 24 volts for the bonus sign mounted between the games.

ASSEMBLY

1. **Console:** To open the console, unlock the ticket and coin doors, reach in and up to release the latches located inside front right and left respectively (see picture below).

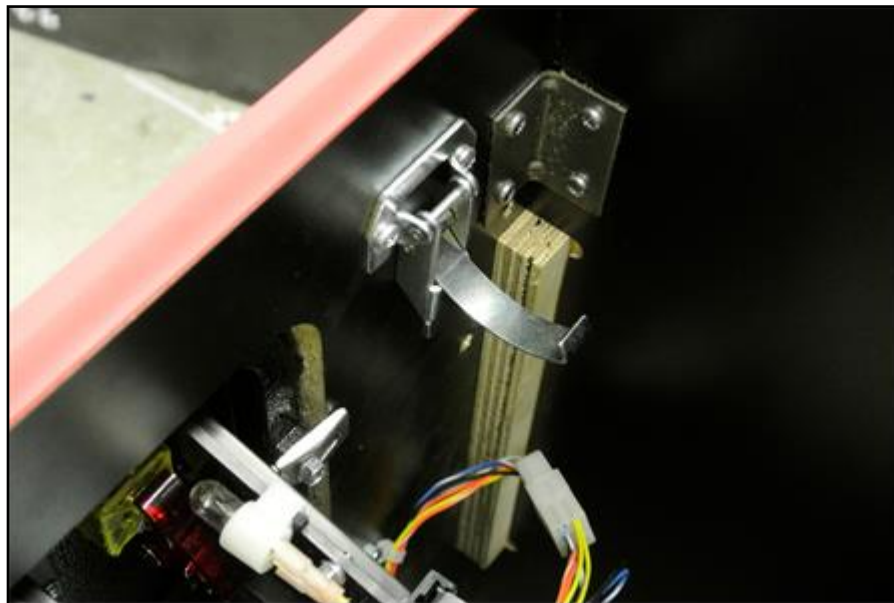

Once released, lift the console lid to open. The wire harness connecting the front console to the main body has multiple connections. The connectors for optical sensors are labeled A, and B. The connectors are such that no accidental mismatching should occur. Power is run through a separate hole in the console.

The console attaches to the game using 4 Southco latches (2 high, 2 low, left and right). To secure the console to the main body, turn the latches with 5/16" Allen wrench (see pictures for reference).



Be sure to adjust the front/rear feet on the console to match height of the main body to make it easier to attach the console and body.

2. **Canopy;** 4 steel brackets are required per game to support the canopy. On one end of each bracket there will be a round hole, and on the opposite end a square or “diamond” shape hole. Align the brackets on their flat part so that they form a longish “X” with round holes in the center (see below).



Place canopy connection bracket so that the PEM studs stick up through two brackets on the left, and two on the right. Use an 8-32 nut with captive star washer to secure brackets on stud (see below).

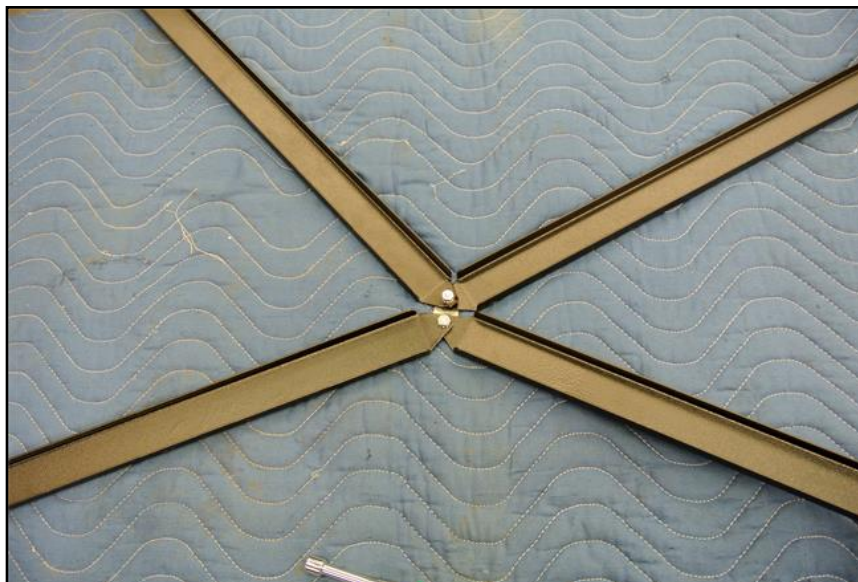

Repeat for the other Pem stud on bracket. Invert the assembly and mount to the four corners of the top of upper frame of the game (2 persons are recommended to perform this part) using ¼-20x3/4” carriage bolts (2) on front of game (see below),



and ¼-20x1” black #3 Philips screws (2) at rear of game (see below).



The canopy rests on top of this frame with “Ring Toss” graphics facing front of game. The canopy has Velcro straps that surround and hold it to the frame.

3. **Bonus sign;** The bonus sign is mounted between two Ring Toss games. An extra power supply is mounted in the upper part of one game, this ‘master’ game should be the left side game (when viewed from the front). At front of and between both games a “boat board” (see the following pictures) is mounted.

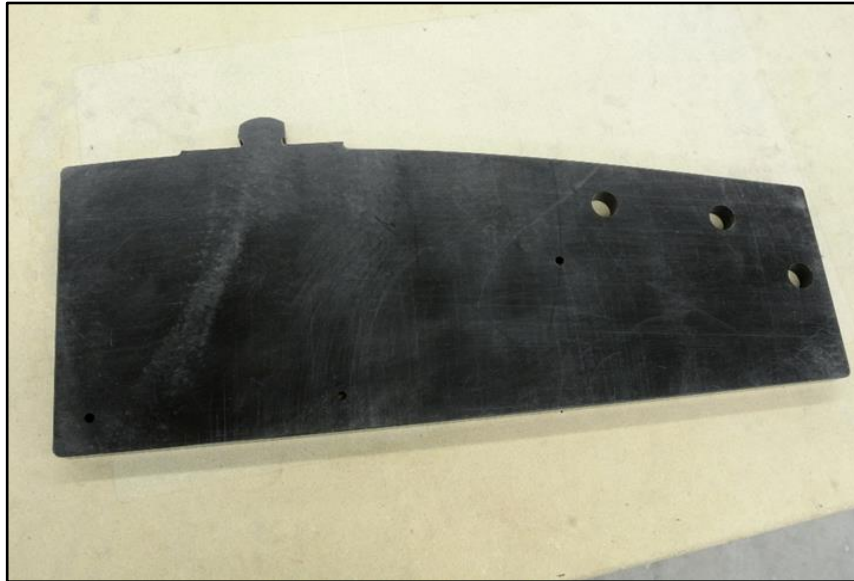



The nub or bump of board goes towards the rear and sits above the profile of the game. Two ¼-20x3-3/4" bolts go through the right side game (in upper hopper area), through the board and are secured with captured outer-star washer nuts on the left game (see below).





A third bolt (1/4-20x2 1/2") goes from right to left underneath the board with the foul line graphics. Next, the post holder bracket is mounted over the two inside arches using 8-32 x 2" screws (*picture-13*).



Place one end of bonus sign pole (the end without the holes to pass bolts) over the nub of the boat board (see picture), and secure it to the post holder bracket with a 1/4-20 x 2 1/2" long carriage bolt, using a nut.



Cover the remainder of the bolt with the black acorn nut. Slide the bracket on the back of the bonus sign over and onto the top of the pole (again, two persons recommended as the sign is heavy). Secure the sign to the pole with two 3" ¼-20 Philips #3 screws (see below).



Plug the 4 pin Molex connector into the harness coming from the game. There is a J-channel bracket to mount between the games at the rear. Use three ¼-20 bolts to go through one game side, then the bracket, then the other game (see pictures below).

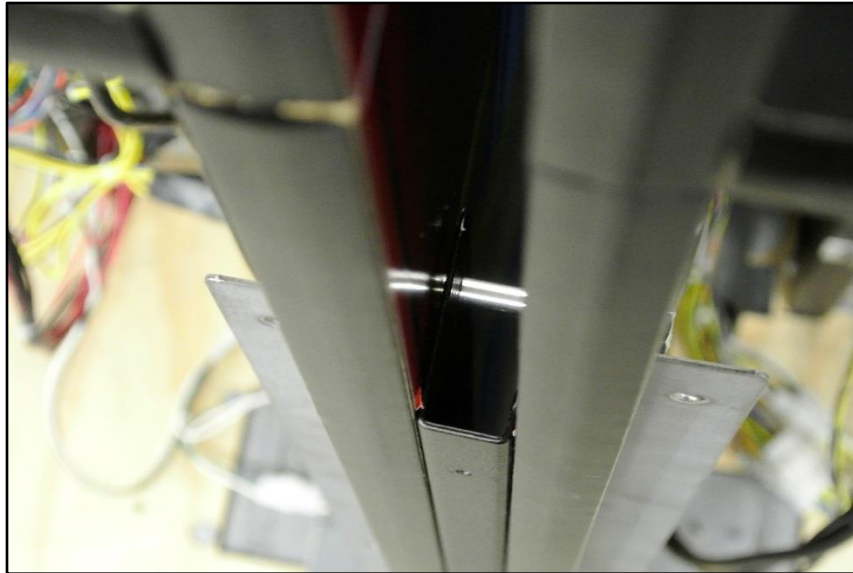
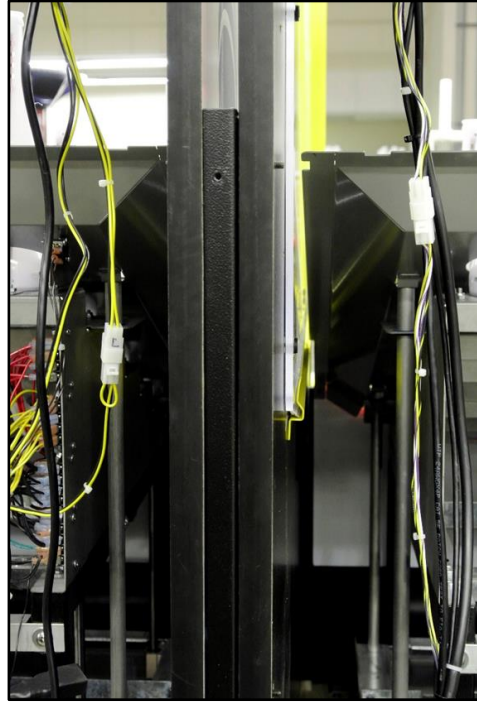
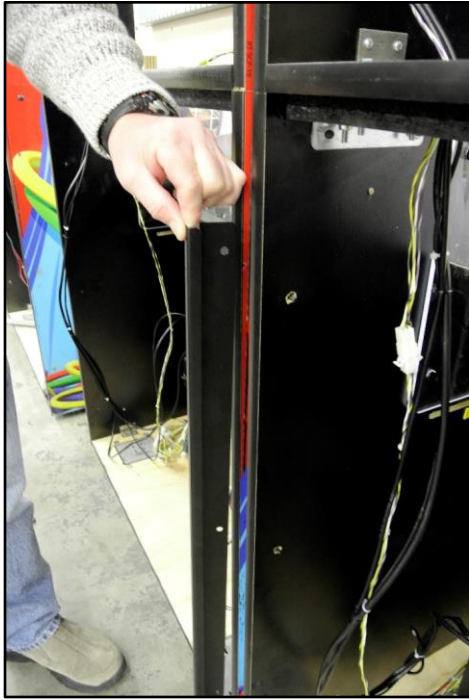

CAMERA CALIBRATION

The overhead camera used to detect the rings on the bottles may become misaligned during shipping. ***We highly recommend recalibrating the camera after installing the game and before game play.***

To check calibration, do the following:

1. Enter the **MAIN MENU** (access buttons are located beneath the top lid of the console).
2. Select DIAGNOSTICS.
3. Select CALIBRATE CAMERA.

You will see a screen similar to the following:

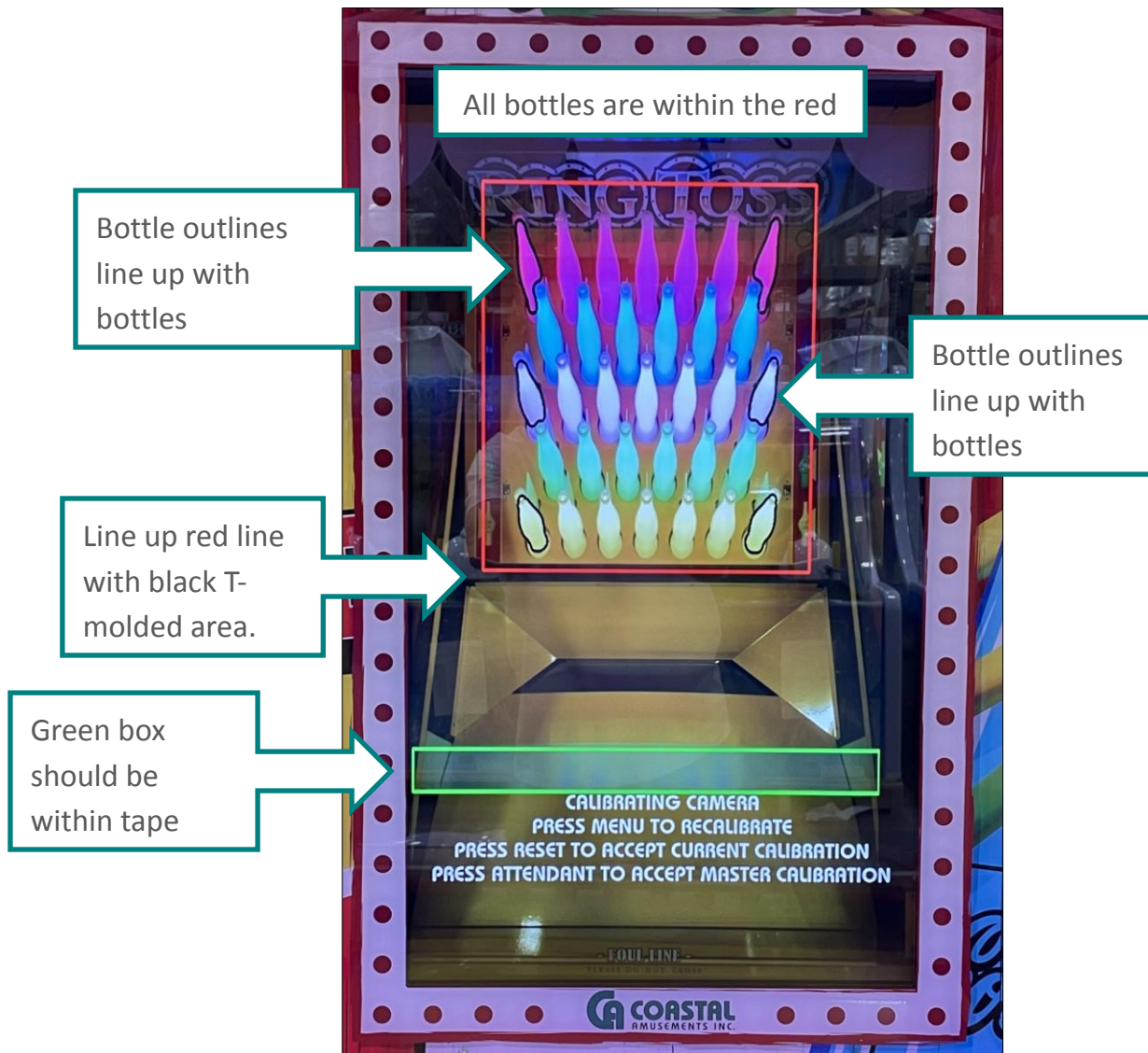

4. Be sure that the black outline around the first and last bottle in the odd rows are approximately surrounding the actual bottles in the image (as shown in photo above).
5. All of the bottles should be within the red box outline (as shown in the photo above).
6. The bottom edge of the red box should be in the black area between the tray and the hopper (as shown in the photo above).
7. The green box on the bottom should be totally within the reflective tape that is used to observe the foul line (as shown in photo above).

If the image does not look correctly aligned, do the following:

1. Loosen the camera mount and adjust the camera so that it is correctly aligned.
2. There are two nuts in the rear of the camera mount that can be loosened to allow the camera to move left and right. See the following photo (green arrows are pointing to the nuts):

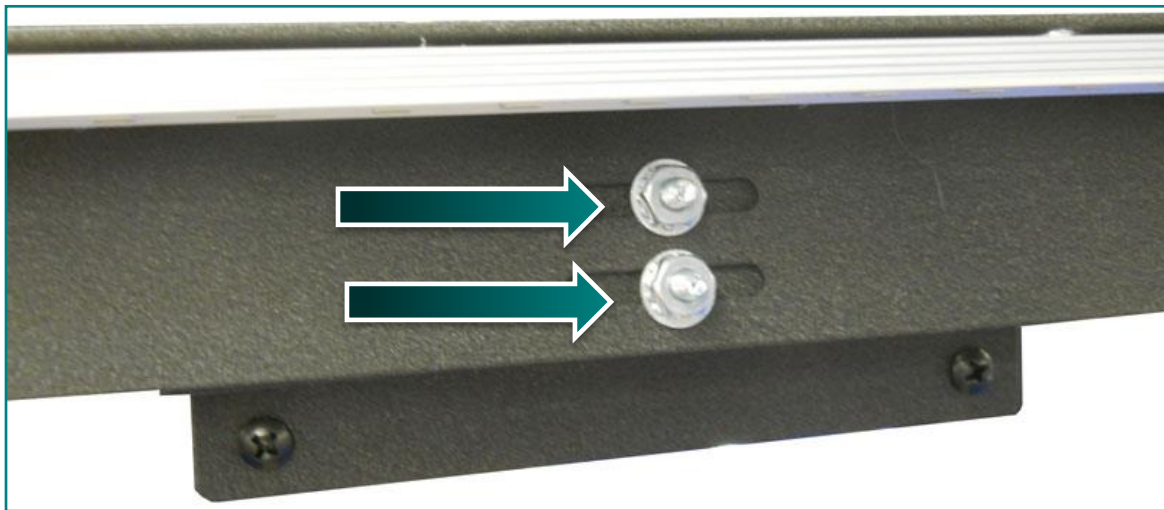

3. Once you have the camera aligned left-to-right and have tightened the nuts back up, you can loosen the screws on the sides of the camera mount to adjust the angle of the camera (green arrows are pointing to the screws):

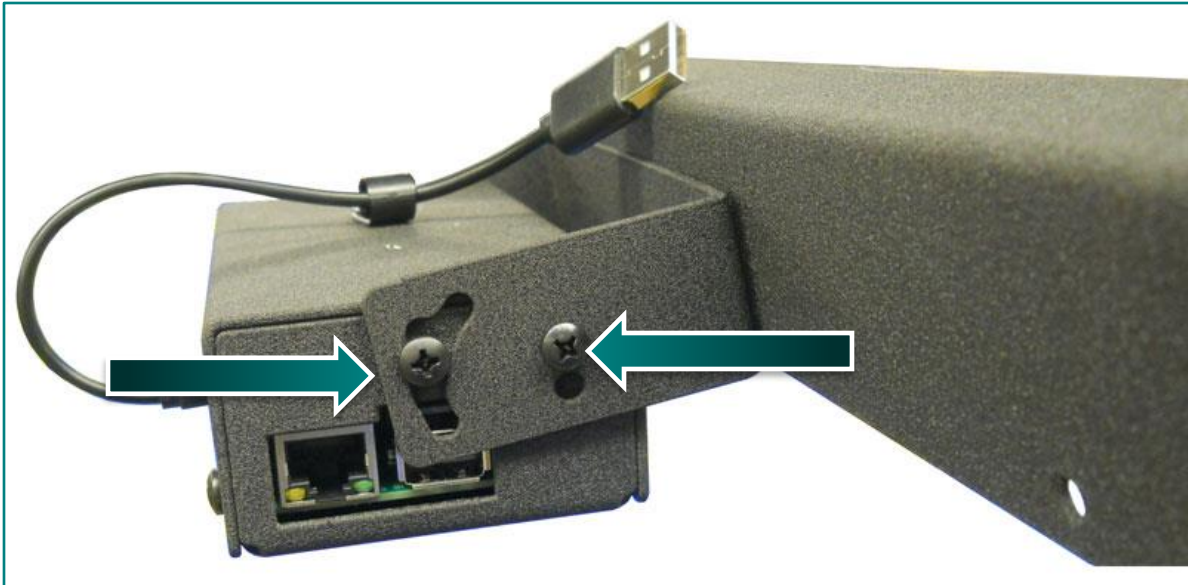

4. There are two screws on either side of the camera mount. Loosen the screws as little as possible so that the angle of the mount can be adjusted and stay in place once you let go of the mount.
5. Once you have the camera aligned as best as possible, tighten the screws and **then press the MENU button to recalibrate the camera.**

After pressing the Menu button to recalibrate the camera, the following will happen:

1. The game will now attempt to calibrate the camera by first lighting all of the rows of seven bottles and taking a picture.
2. Then the rows of six bottles will light up and a picture will be taken.
3. Finally, all the bottles will be lit up in their respective row colors and a final calibration picture will be taken.

If the game still does not calibrate successfully, press the ATTENDANT button and the software will use the factory default calibration image which will allow the game to function.

This can be used if, for example, some bottles are currently not lighting up or the location's lighting is interfering with the calibration.

If you have any questions or comments, please our service department at +1 732 905 6662. We are open Monday through Friday 09:00 AM – 16:30 PM EST (USA).

INTERNET OPTIONS INSTRUCTIONS

Your machine's software contains an option to connect through the internet to Coastal Amusements. This will allow the game to report its accounting information and settings to us and suggest changes to improve income generation. It will also allow the game to receive any software updates / bug fixes without the need to have the software shipped to you. The next pages will explain how to enable this setup.

To enter the configuration screen, connect a keyboard to the motherboard. Then enter the menu and select the option titled 'INTERNET OPTIONS'. Alternatively, you can just press the Escape key on the keyboard. You will be presented a screen similar to this one:

Internet Settings / Wireless Network

Use the Tab key on the keyboard to move between fields. Click the Scan button to find your wireless network. You can also type the name of your SSID if it is not broadcasted. To switch between DHCP and Static, use the Up/Down arrows. To click a button, tab to it so it is highlighted then press the Space bar.

Location Name

Network SSID

Password

DHCP Use Up/Down arrow keys to select DHCP or Static IP.

Static IP

IP Address . . .

Subnet Mask . . .

Gateway . . .

DNS Server 1 . . .

DNS Server 2 . . .

In the 'Location Name' field, enter your store name and location for reference (i.e. Chuck E Cheese – Baltimore MD).

The Network SSID will show the first wireless network found. If this is not your preferred network, enter the name manually or press 'TAB' until the 'Scan' button is highlighted in yellow and then press space. (If you ever need to 'TAB' back to a previous item, hold down 'SHIFT' when you press 'TAB'). You will then see a screen similar to the following:

Available Wireless Networks

Choose your wireless network from the ones found below. Use the Up/Down arrows on the keyboard or click an item with the mouse. Use the Tab key to move between fields. To click a button, tab to it so it is highlighted then press the Space bar.

If your SSID is not broadcasted it will not be in the list, you will need to click the Cancel button and type it in the Network SSID field.

coastal_guest
coastal
coasteng
HP87151C

Select

Cancel

Use the up/down arrows to select the network you wish to use, then press 'TAB' to highlight the 'Select' button and press the space bar.

If your network uses DHCP (usually the case), leave the DHCP button selected. If you use static IP addresses, select the Static IP button.

If you selected Static IP, you will need to enter the correct information into the next fields. Consult your ISP for the correct addresses for your location. If you do not have a second DNS server, you can enter 8.8.8.8 or 8.8.4.4 to use Google's DNS servers or find another public DNS server on the web.

When all fields are correctly filled out, tab down to the 'Save' button and press the spacebar. You will then see the following screen:

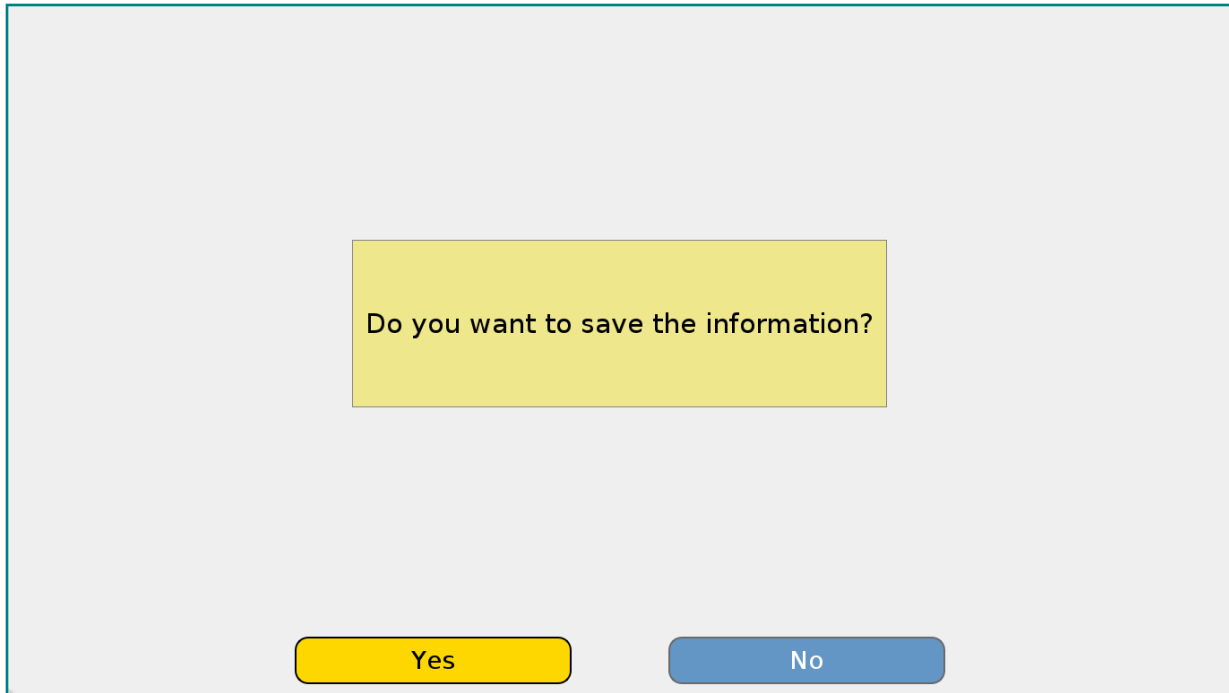

Press the spacebar to select 'Yes' and you will see this screen:

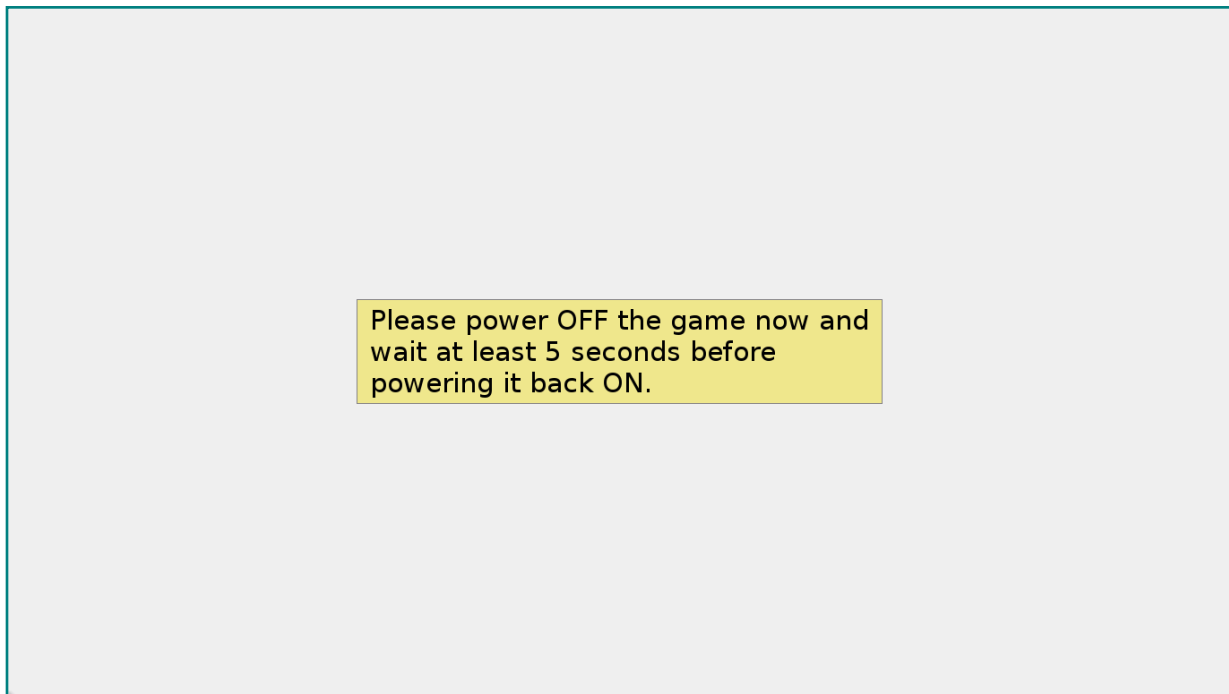

You can now remove the keyboard and reboot the game. Upon reboot, the game will then attempt to make an initial contact with our server.

If you have any questions, call Coastal Amusements at +1 (732) 905-6662. Support is available from 08:00 to 16:30 PM EST, Monday through Friday.

RING TOSS MENU OPTIONS

Press the **Menu** button to enter the system set up and then use the following buttons to navigate through the menus:

ATTENDANT: Use to move **up** in the menu and to **increment** values

RESET: Use to move **down** in the menu and to **decrement** values

MENU: Use to **select** a menu item, and to **set** menu item values

MAIN MENU

PRICING ADJUSTMENTS

Setting	Options	Default	Description
FREE PLAY	ON/OFF	OFF	When set to 'ON' the mechanical meters will be disabled, no tickets will be paid, and 'FREE PLAY' will be displayed on the screen. An external switch must be attached to one of the coin mech inputs to simulate a coin drop.
CARD PLAY	ON/OFF	OFF	Select 'ON' if you are using a card device instead of cash.
CREDITS TO START	1-10	2	Set this option to the number of credits needed to start one game. <i>This option is disabled when "Card Swipe" is set to 'On'.</i>
COIN CHUTE 1 CREDIT	1-10	1	This option controls how many credits are given for each coin inserted into coin mech 1. <i>This option is disabled when "Card Swipe" is set to 'On'.</i>
COIN CHUTE 2 CREDITS	1-10	1	This option controls how many credits are given for each coin inserted in to coin mech 2. <i>This option is disabled when "Card Swipe" is set to 'On'.</i>
DBV CREDITS	1-10	4	This option sets the number of credits given when a dollar bill (\$1.00) is inserted.
TICKET VALUE	\$0.001 to \$0.10 (\$0.001 increments)	\$0.01	This option should be set to the cash value of one ticket. Note: This setting must be accurate in order to correctly calculate the overall percentage payout of the game.

CREDIT VALUE	\$0.10 TO \$5.00	\$0.25	Set this option to the monetary value of one credit for accurate bookkeeping stats. Note: This setting must be accurate in order to correctly calculate the overall percentage payout of the game.
--------------	------------------	--------	--

PAYOUT ADJUSTMENTS

Setting	Options	Default	Description
ENABLE PAYOUT	OFF, DURING GAME PLAY, AT END OF GAME	DURING GAME PLAY	Setting this to off will prevent the ticket dispenser from dispensing tickets (or the card system from receiving wins). DURING GAME PLAY pays tickets while the game is in play. AT END OF GAME pays tickets at the end of the game.
POINTS PER TICKET	1-100	10	This value determines how many points are needed to award one ticket.
MERCY TICKET THRESHOLD	OFF, 1-40	OFF	When set, this is the minimum number of tickets awarded to the player, regardless of score.

GAME ADJUSTMENTS

Setting	Options	Default	Description
VOLUME	0-100	50	This option sets the main volume during game play.
ATTRACT SOUND	ON/LOW VOLUME/OFF	ON	Select whether or not you want attract sound on, off, or at a lower volume in the attract mode, than game play.
GAME TIME	20-90	30	This setting determines the length of one game play (in seconds).
FOUL LINE HANDLING	OFF, END GAME AFTER 2 FOULS, END GAME AFTER 3 FOULS, END GAME IMMEDIATELY, DELAY GAME & CONTINUE	DELAY GAME & CONTINUE	If the foul line is active, and a foul is detected the game will either warn the player and end the game (after 1, 2, or 3 fouls), or warn the player then continue play. No points are scored while a foul is detected.
FOULS IN ATTRACT	ON/OFF	ON	When on, fouls will be detected in attract mode.

BONUS ADJUSTMENTS

Setting	Options	Default	Description
BONUS OPTION	Tickets, Free Game	Tickets	By default, the game is set to pay tickets when the bonus is won. You can optionally set the game to award a free game when the bonus is won by changing this value to FREE GAME.
BONUS POINTS THRESHOLD	400-950	850 (Tickets) 500 (Free Game)	This sets how many points are need to win the progressive bonus. Decals are provided to change values.
BONUS RESET (MINIMUM) VALUE	10-9999	1000 (not used with free game option)	This setting will determine the beginning value of the Bonus, after a win.
BONUS MAXIMUM	10-9999	9999 (not used with free game option)	The setting determines the highest Bonus value. The progressive value will stop, once the set maximum is reached. Setting the Reset (minimum) value and the Maximum value to the same level, will cause the Bonus to be stable (non-progressive).
PLAYS TO INCREMENT BONUS	1-10	1 (not used with free game option)	This option controls how many plays are needed to increase the progressive bonus, in conjunction with the option below.
BONUS INCREMENT VALUE	1-10	1 (not used with free game option)	This option controls how much the progressive bonus will increase with the number of games played (set in the previous option).
RESET ON POWERUP	ON/OFF	OFF	When set to on, the bonus will be reset to the set reset value when power to the game is cycled.

DYNAMIC THRESHOLD	ON/OFF	OFF	Setting this option to ON will enable the next 5 options to dynamically control the points needed to win the bonus.
MINIMUM BONUS THRESHOLD	100-400 (by 50s)	200	This setting is the minimum value that the threshold can decrease to.
START / MAX BONUS THRESHOLD	500-950 (by 50s)	700	This setting sets the starting points threshold value. It will also never go above this number.
THRESHOLD INCREMENT	10-100 (by 5s)	50	When a bonus is won, the threshold will increase by this amount, but will not go over the START / MAX BONUS THRESHOLD.

THRESHOLD DECREMENT	5-25 (by 5s)	5	When the bonus is not won within the number of games in the next option, the threshold will decrease by this amount, but never go below MINIMUM BONUS THRESHOLD.
BONUS MISSES UNTIL DECREMENT	1-50	1	This setting controls the number of missed bonus games needed to decrement the threshold value by THRESHOLD DECREMENT.

Using the default dynamic threshold settings works as follows:

The initial score needed is 850 points.

Every (1) game that the bonus is not won, the score needed will decrement by 5 points.

It will never go below 200 points.

When a bonus is won, the score needed will increase by 50 points.

It will never go higher than 850 points.

LINK ADJUSTMENTS (Not used with free game option)

Setting	Options	Default	Description
PROGRESSIVE BONUS SIGN	ON, OFF	OFF	If you are using the progressive bonus sign, you must set this option to ON.
GAME NUMBER	OFF, MASTER, 2-10	OFF	The game that has a progressive sign attached to it must be set as the MASTER. Any other games linked will need to be assigned unique values of 2 through 10. Any game setting changes are only able to be set on the MASTER game, and they will transfer to the linked slave games (2-10). When you are in this screen on the MASTER game, it will show you if any games are linked by changing the text NOT LINKED in red to LINKED in green.

AUDITS

	CURRENT	LIFETIME
COIN CHUTE 1 CREDITS	0	0
COIN CHUTE 2 CREDITS	0	0
DBV CREDITS	0	0
TOTAL CREDITS	0	0
FREE PLAYS	0	0
PAID PLAYS	0	0
TOTAL GAMES PLAYED	0	0
GAME TICKETS	0	0
BONUS TICKETS	0	0
TOTAL TICKETS	0	0
AVERAGE TICKETS	0.00	0.00
BONUS HITS	0	0
BONUS HITS %	0.00%	0.00%
BONUS TICKET %	0.00%	0.00%
OPERATING %	0.00%	0.00%
RINGS ON ROW 1	0	0
RINGS ON ROW 2	0	0
RINGS ON ROW 3	0	0
RINGS ON ROW 4	0	0
RINGS ON ROW 5	0	0
RINGS ON ROW 6	0	0
RINGS ON ROW 7	0	0
TOTAL RINGS	0	0
AVERAGE RINGS PER GAME	0.00	0.00
TOTAL POINTS	0	0
AVERAGE POINTS PER GAME	0.00	0.00
TOTAL FOULS	0	0

This screen will show all bookkeeping information. Pressing RESET on this screen will clear the current audits. A screen will appear asking to confirm that you want to do this.

DIAGNOSTICS

AUDIO TEST:	These options test the speaker output.
I/O TEST:	In this test, you can raise and lower the lifting tray and also run the hopper motor. This screen will also show the status of the ring detector sensors and the tray down switch.
LED TEST	This test will allow you to cycle through the colors of the RGB LEDs in the bottles by pressing MENU on the BOTTLE RGB LEDS line. The sequential bottle test will light each bottle white one at a time in each row starting with the bottom row.
CALIBRATE CAMERA	This will perform a recalibration of the ring sensing and foul line sensing camera. See Troubleshooting below for more information.
RESTORE FACTORY SETTINGS	Selecting this option will restore all settings to factory default values.
CLEAR CREDITS	Selecting this will clear all credits on the game that are less than the amount needed for one play. If you need to clear all credits while a game is in play, press the RESET button during the game and the credits will be cleared.
CLEAR TICKETS	Selecting this will clear all tickets owed on the game.
RESET BONUS	This option will let you reset the progressive bonus to the minimum value you have set in BONUS ADJUSTMENTS.
INTERNET OPTIONS	Selecting this option will allow you to connect your machine to the internet via wifi in order to receive remote software updates and support. Follow the on-screen instructions to use.
EXIT WITHOUT SAVING	Exit the menu without saving any changes.
SAVE AND EXIT	Save any changes made and exit the menu.

MAINTENANCE

The following maintenance suggestions will help ensure that the game operates properly at all times.

LIFTING TRAY CLEANING

To prevent rings from remaining on the lifting tray when it is raised, it is recommended that you clean the tray occasionally with a silicone-based lubricant. More frequent cleaning may be necessary in high humidity environments.

RING SENSOR HOLES

Be sure that the sensor holes in the ring console tray are not obstructed by any dirt or other debris.

CAMERA

You may want to occasionally go into DIAGNOSTICS and select the CALIBRATE CAMERA option to be sure the camera has not been moved out of position.

RING HOPPER

Occasionally check the game to be sure that there are at least 60 rings in the ring hopper. You can do this by either starting a game and collecting all the rings from the hopper, or you can run the hopper motor from the DIAGNOSTICS menu. Also, see that there are no foreign objects inside the hopper, as this can cause a hopper jam.

WE RECOMMEND THAT YOU LOAD ALL 70 RINGS INTO THE HOPPER TO AVOID ANY CHANCE OF 'HOPPER STARVATION'.

TROUBLESHOOTING

1. **NO POWER:** Make certain the game is plugged into the mains and the mains are “live”. Make certain the power part of harness (white 16-gauge wires with 2-pin Molex connector) at the console has been connected and the interlock switch in the console is in the up (on) position. Check rear power module to be certain the switch is on. Check fuse inside power module, replace if damaged.

2. **HOPPER ERROR:** Should game-play stop and this error appears on the monitor: “HOPPER ERROR”, the hopper has been running for longer than 15 seconds without seeing any rings pass into the trough. This error can be caused by one or more of the conditions listed below. After the condition has been cleared, press the reset button and close the console lid to restart the hopper. **A hopper error can be caused by one or more of the following conditions:**
 - A. One or more rings have become wedged at an angle just below the hopper exit and is blocking the optical sensor. Open console lid to access this area. Remove ring, press the reset button and close the console lid.

 - B. An error can occur when too many rings get stuck on the hopper side of the trough wall. Lifting the console lid will allow access to the hopper side of the trough. Clear rings, press the reset button and close the console lid.

 - C. A ring jam can occur within the lower part of the hopper, this may indicate too many rings are in “reserve” at the bottom. Loosen rings by hand, press the reset button and close the console lid.

 - D. Rings get under the hopper disk. Should this be the case, remove ALL rings from the hopper. Gently/slowly rotate hopper wheel (counter clockwise) to allow rings underneath to be removed. This may prove difficult if some rings are wedged firmly. Check bottom of hopper to make certain it is free of debris. Once all rings have been removed from under the wheel and the wheel is flat and rotating freely (by hand), reload the rings, press the reset button and close the console lid.

 - E. Should the game run out of rings (all rings are on bottles), hopper error will appear since no rings are passing by the hopper sensor. This is a rare ‘starvation’ occurrence and will clear itself, once the game times out of play. If not, press the reset button and close the console lid.

3. **SWITCH ERRORS:** Lower tray limit switch: There is one spring contact switch for the tray table (there is a time window of 11 seconds for contact closure before game generates an error). The position of the switch is counter-intuitive, the switch located at the top of the list mechanism and reads the lower-limit (tray down position). Check the connection on switch and harness, check with a meter that contact closure works. Adjustment of switch mounting may be required.

4. **OPTICAL SENSORS:** There is a sensor for the trough on the hopper side of the wall that has a dual purpose. To detect if there are too many rings on that side of the wall and in as a safety measure to avoid injury should someone reach too far into the trough. In both cases the game will stop the hopper immediately until that condition is cleared, then resumes game play. To check sensors, go to the I/O section in the diagnostics menu. Status of the sensors is displayed live.

5. **NO CONNECTION TO SERVER:** The Pi board is unable to communicate with the camera. Make sure the RJ-45 cable and USB cable are plugged in at the camera and at the Pi board (no USB port is preferred over any other, but it needs to be plugged into one).

CAMERA CALIBRATION PROBLEMS: If the machine is having trouble detecting rings on the bottles, the camera may not be calibrated correctly. To check this, enter the menu, select DIAGNOSTICS, and then select CALIBRATE CAMERA. You will see a screen similar to the one on the next page,

You want to be sure that the black outlines of the first and last bottles in the odd rows are surrounding the actual bottles. If they are not, you can loosen the screws securing the camera assembly and move the camera so that it is correctly aligned. Then you can press the menu button to recalibrate the camera.

If the bottles are aligned correctly, but you are still having ring detection problems, pressing the ATTENDANT button will use the factory default calibration image, which should correct any problems you may have.

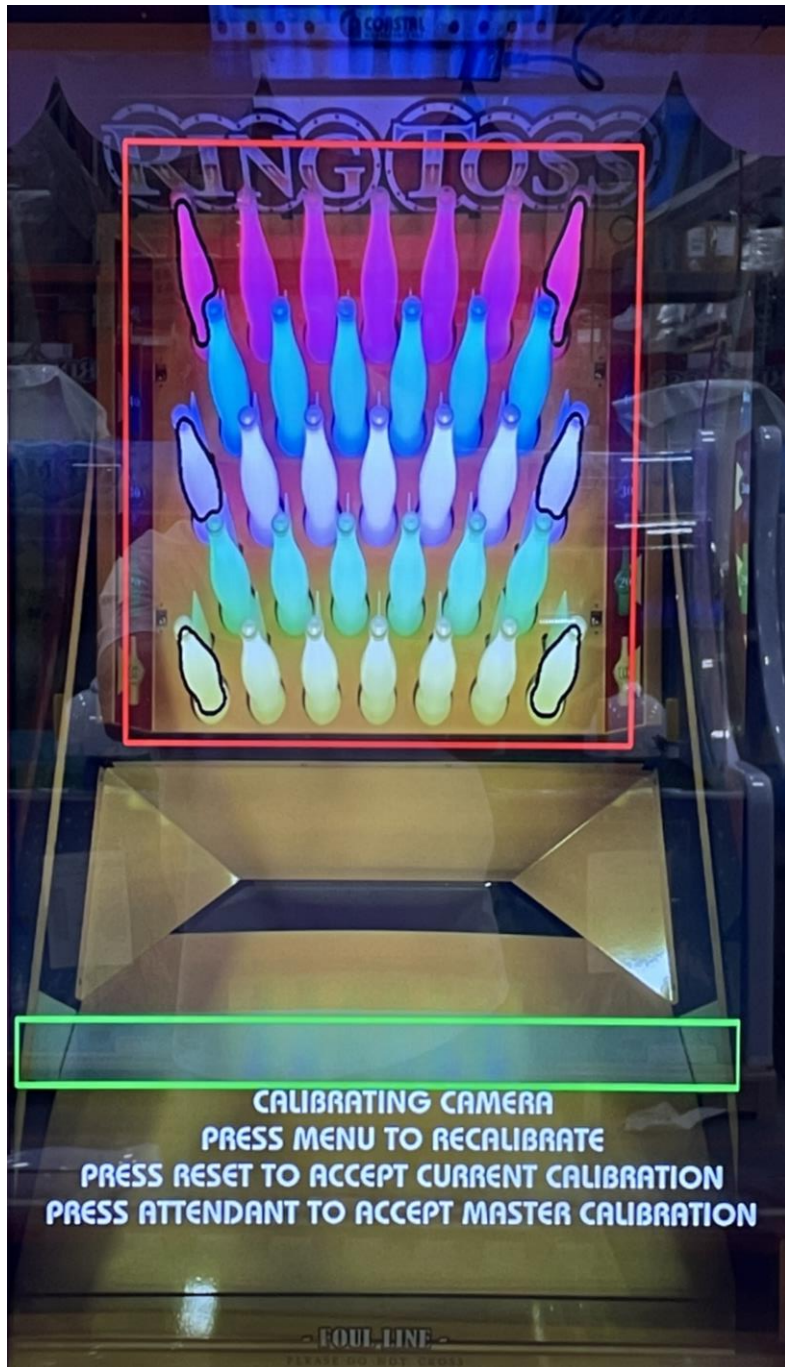

If you have any questions or comments, please our service department at +1 732 905 6662. We are open Monday through Friday 09:00 – 16:30 EST (USA).

EXPLODED DIAGRAMS

ITEM #	Part No.	DESCRIPTION	QTY.
1	RT-SM-67	LIFTING TRAY	1
2	RT-SCP-17	LIFTING TRAY DECAL SET	2
3	RT-KIT-RT-BOTTLE	BOTTLE ASSEMBLY	46
4	RT-SCP-01	RING SCREEN	1
5	CA-SWI-RT-SPDT15A	TRAY ACTION MICROSWITCH	1
6	RT-SM-30	MICRO SWITCH SUPPORT	1
7	CA-BRG-RT-GROMMET	NYLON 5/8" BEARING FOR 11/16" INSERT	4
8	RT-SM-68	SNAP IN BEARING BRACKET	4
9	CA-MOT-RT-ACTUATOR	LINEAR ACTUATOR "B" STYLE GEARBOX	1

- Ring Toss Lift Mechanism Shown, Junior Version omits first 2 rows of bottles

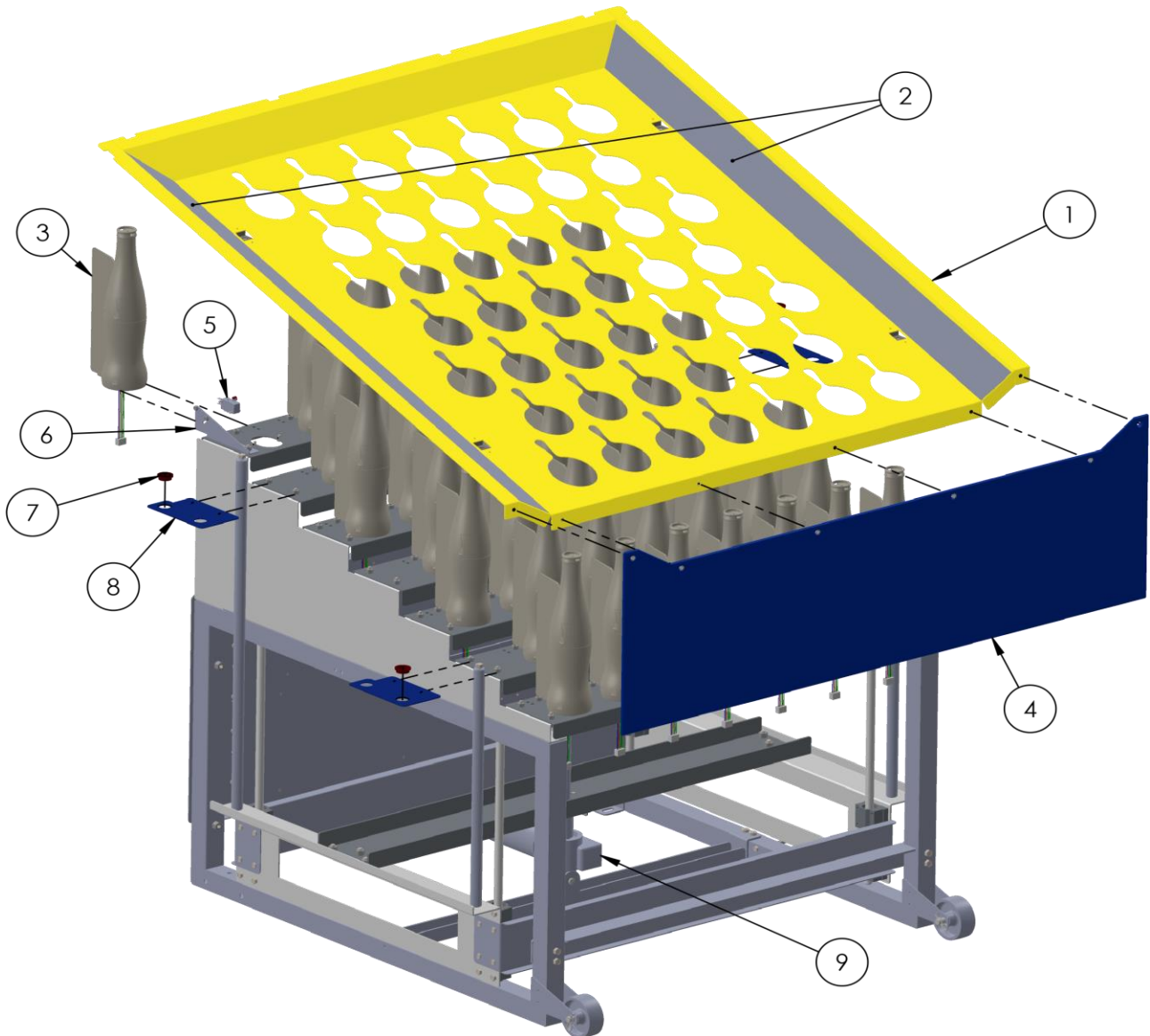

ITEM #	PartNo	DESCRIPTION	QTY.
1	RT-PLS-02	TUMBLER SIDE WALL	1
2	RT-PLS-09	RING WALL	1
3	RT-IMP-03	RING TOSS RING	1
4	RT-PLS-14	ELEVATOR PLATE HOLD DOWN	1
5	RT-PLS-03	TUMBLER ELEVATOR	1
6	RT-SM-77	TUMBLER HUB	1
6	RT-SM-105	ELEVATOR PINCH PLATE	1
7	RT-PLS-10	LONG AGITATOR	3
8	RT-PLS-11	HOPPER RING PAD	1

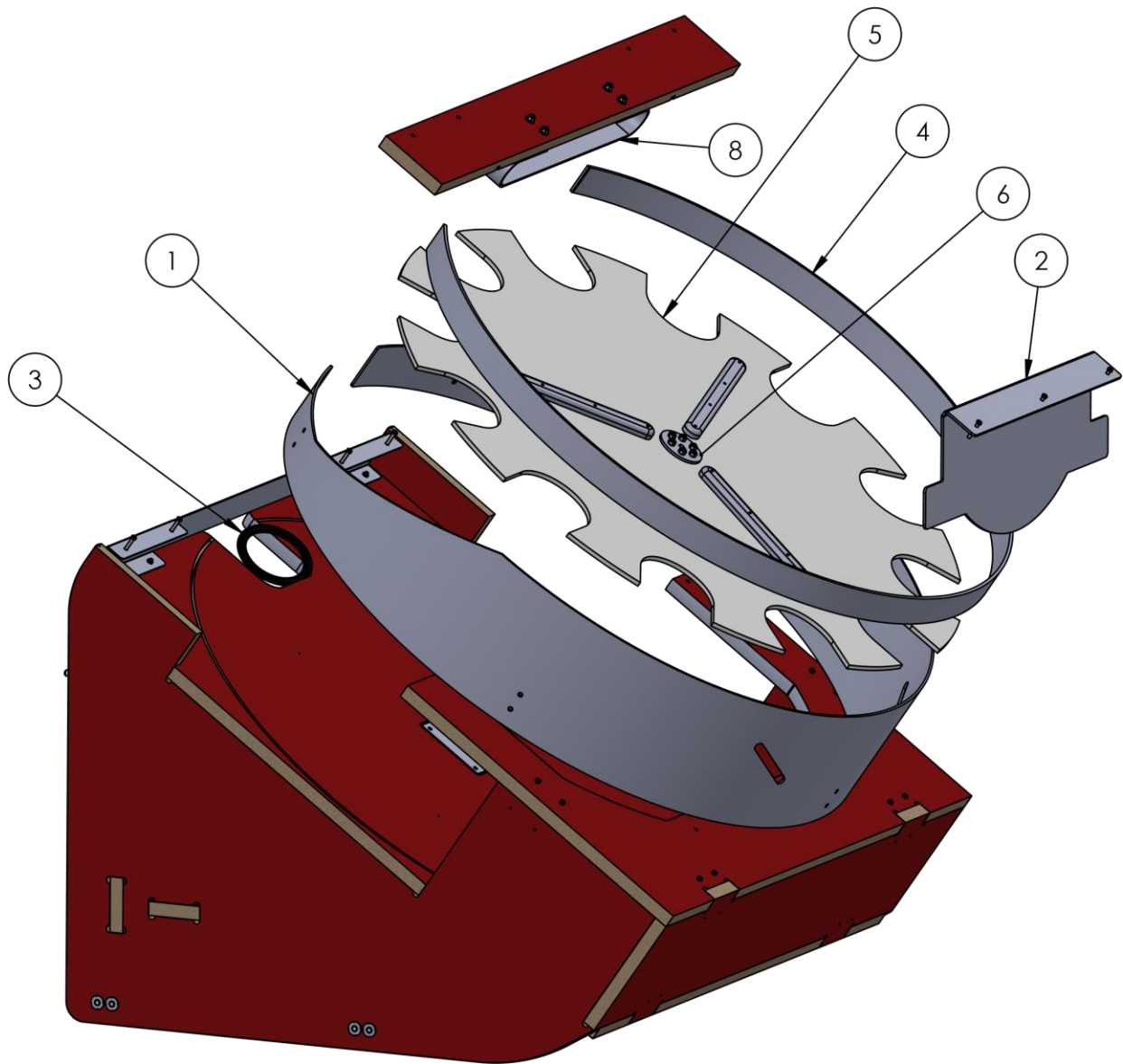

ITEM #	PARTNO	DESCRIPTION	QTY.
1	CA-SEN-RT-OPB100EZ	RING DETECT OPTO SWITCH	1
2	CA-SEN-RT-OPB100SZ	RING DETECT OPTO SENSOR	1
3	RT-SM-22	OPTO HOLD DOWN	2
4	RT-SM-107	HOPPER SINGLE OPTO MOUNT	2
5	CA-MOT-RT-SP7456	HOPPER MOTOR	2
6	RT-SM-111	INTERLOCK BRACKET	1
7	CA-SWI-RT-E6930A	CHERRY INTERLOCK SWITCH	1
8	CA-FUS-RT-F6669ND	FUSE 8AMP SLO-BLO FOR MOTOR	1

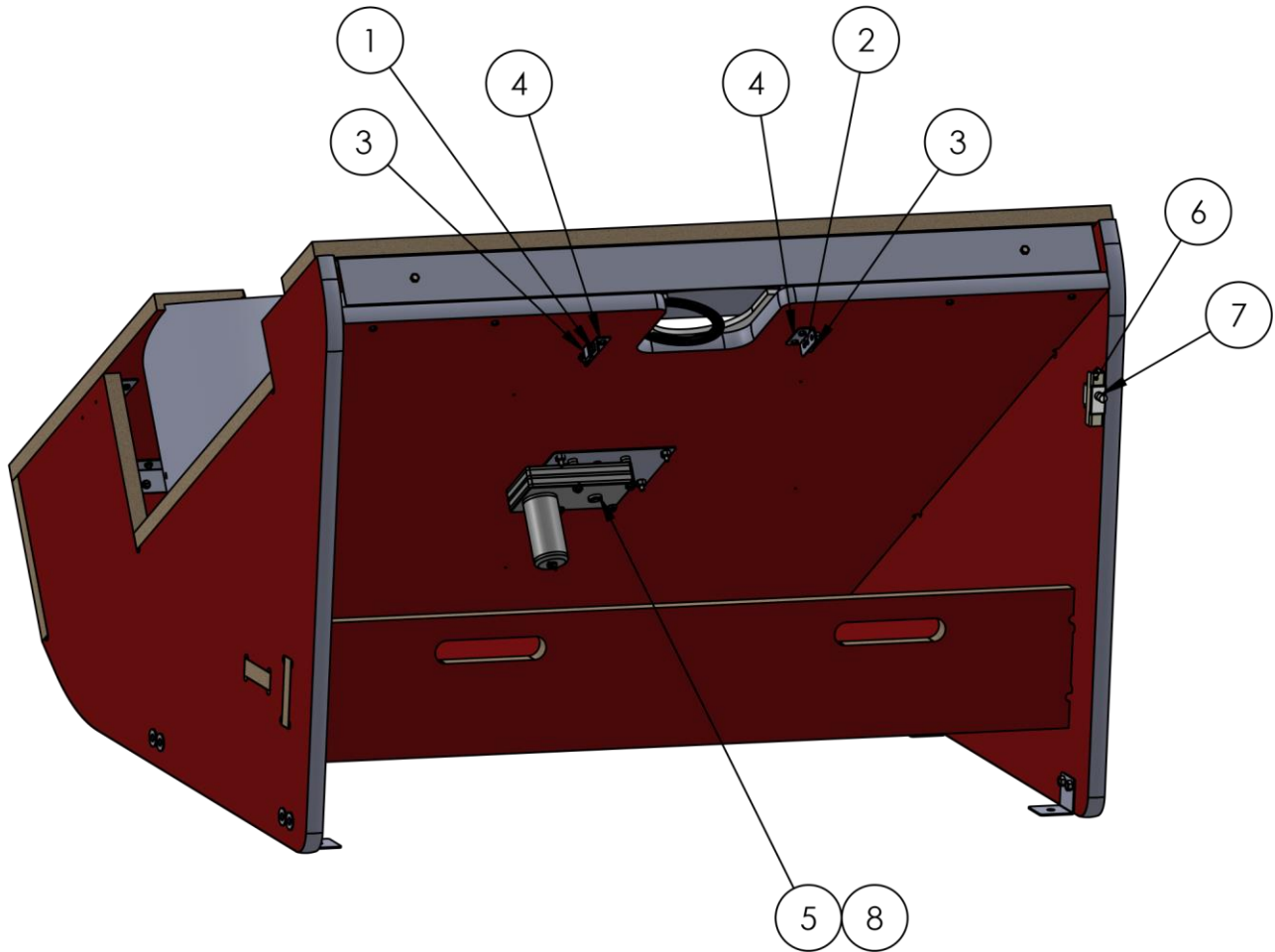

ITEM NO.	Partno	DESCRIPTION	QTY.
1	RT-PLS-03	TUMBLER ELEVATOR	1
2	RT-SM-105	ELEVATOR PINCH PLATE	1
3	RT-PLS-10	LONG AGITATOR	3
4	RT-SM-77	TUMBLER HUB	1
5	-----	8-32 ELASTIC STOP NUT	6
6	CA-MOT-RT-SP7456	HOPPER MOTOR	1

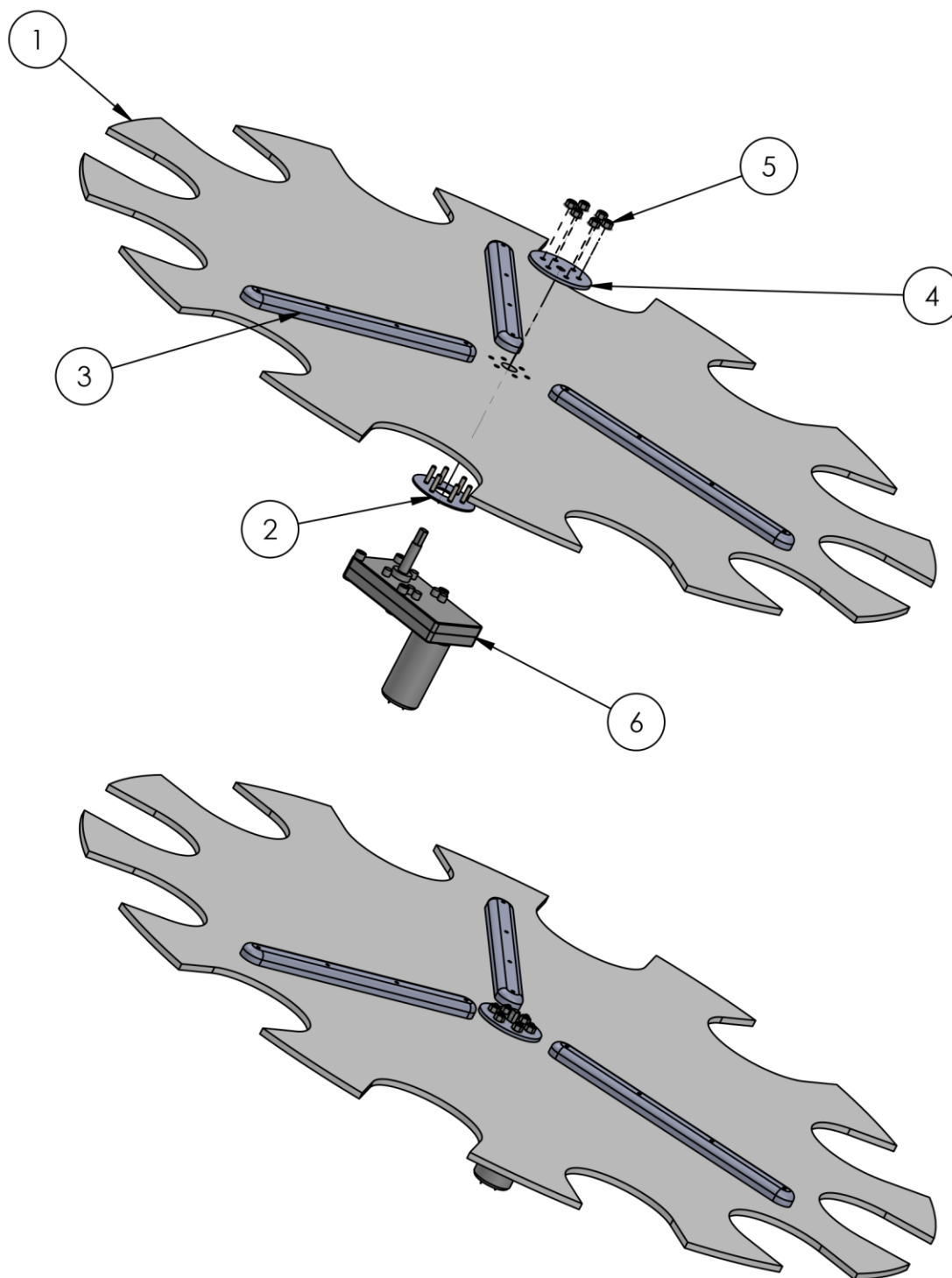

ITEM #	Partno	DESCRIPTION	QTY.
1	CA-PS-RT-SE6005	POWER SUPPLY MEANWELL SE-600-5	1
2	CA-PS-RT-SE35012	POWER SUPPLY MEANWELL SE-350-12	1
3	CA-SUB-PCB-PIBOARD	PI I/O BOARD ASSEMBLY	1
4	CA-MOT-RT-218CYT3	CYTRON 13A DC MOTOR DRIVER MD133	1

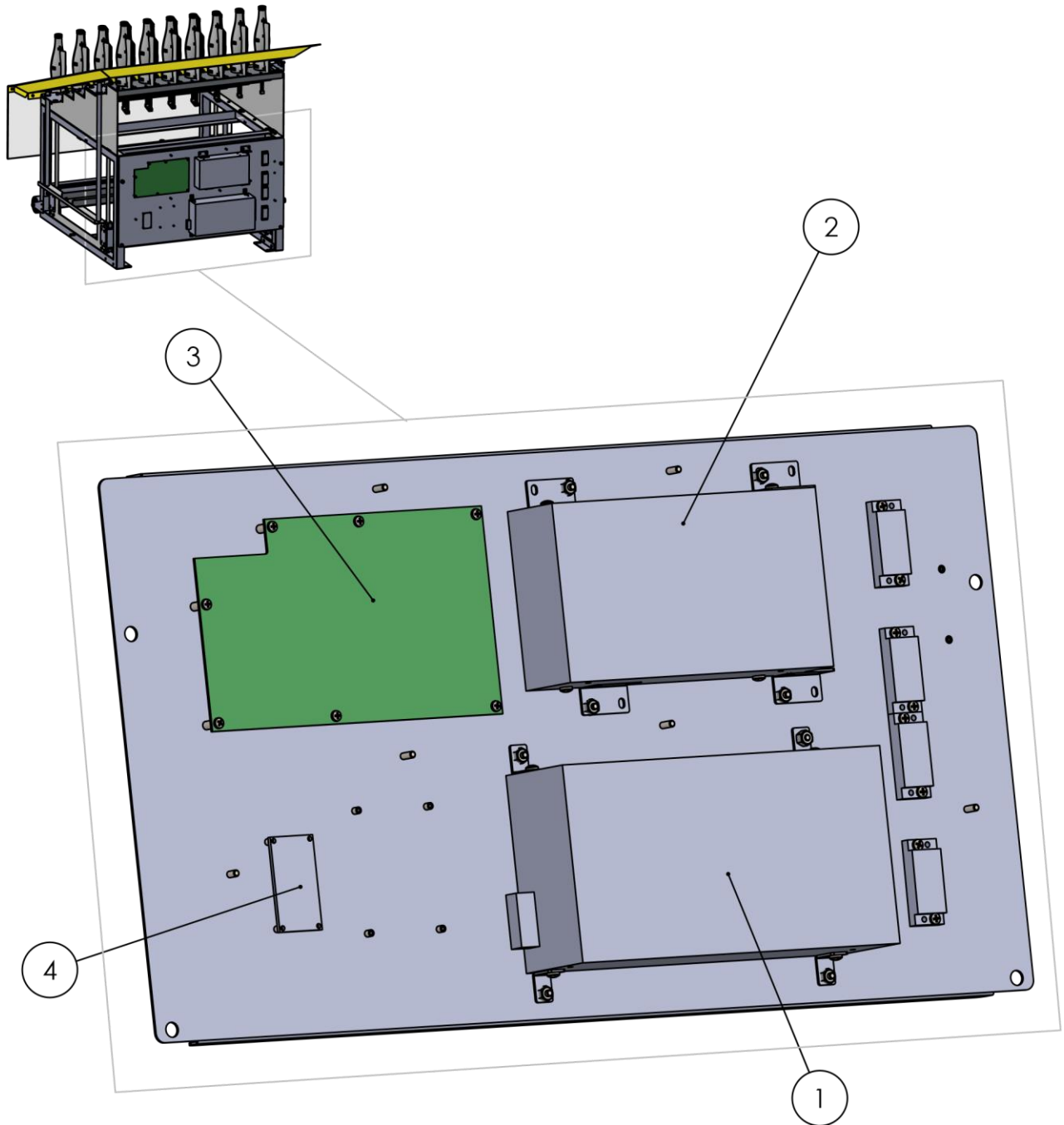

ITEM #	PARTNO	DESCRIPTION	QTY.
1	CA-KIT-RT-CAMERA	CAMERA HOUSING ASSEMBLY	1
2	RT-SM-118	CAMERA SLIDE C BRACKET	1
3	RT-SM-94	CAMERA CROSSBAR	1

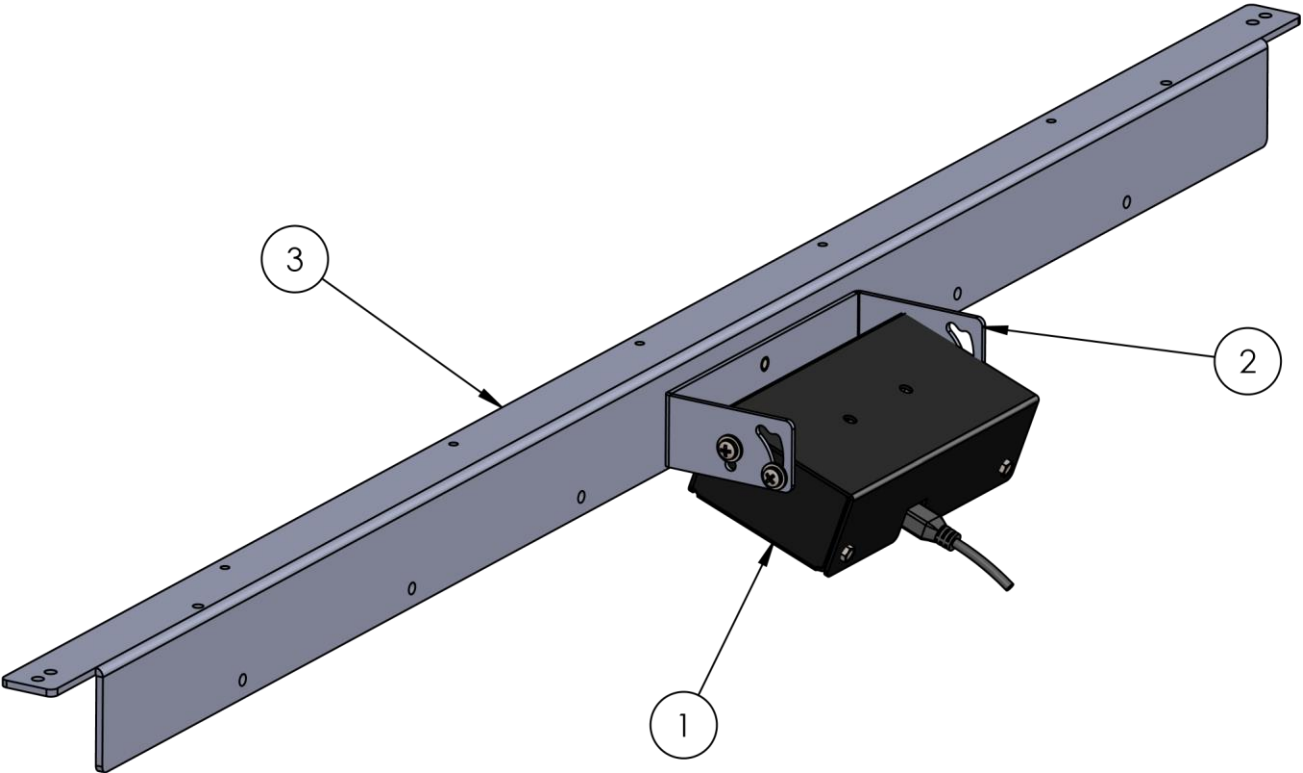

ITEM #	Part #	DESCRIPTION	QTY.
1	RT-SCP-03	MONITOR COVER	1
2	RT-WD-06	MONITOR BACK DOOR	1
3	49-0067-00	HAPP VENT HANDLE	1
4	CA-SPE-MM-BRS40	SPEAKER	2
5	CA-MON-LCD-32	MONITOR	1
6	CA-PLU-RT-716WX201	AC RECEPTACLE	1
7	RT-SM-113	IEC PLATE	1

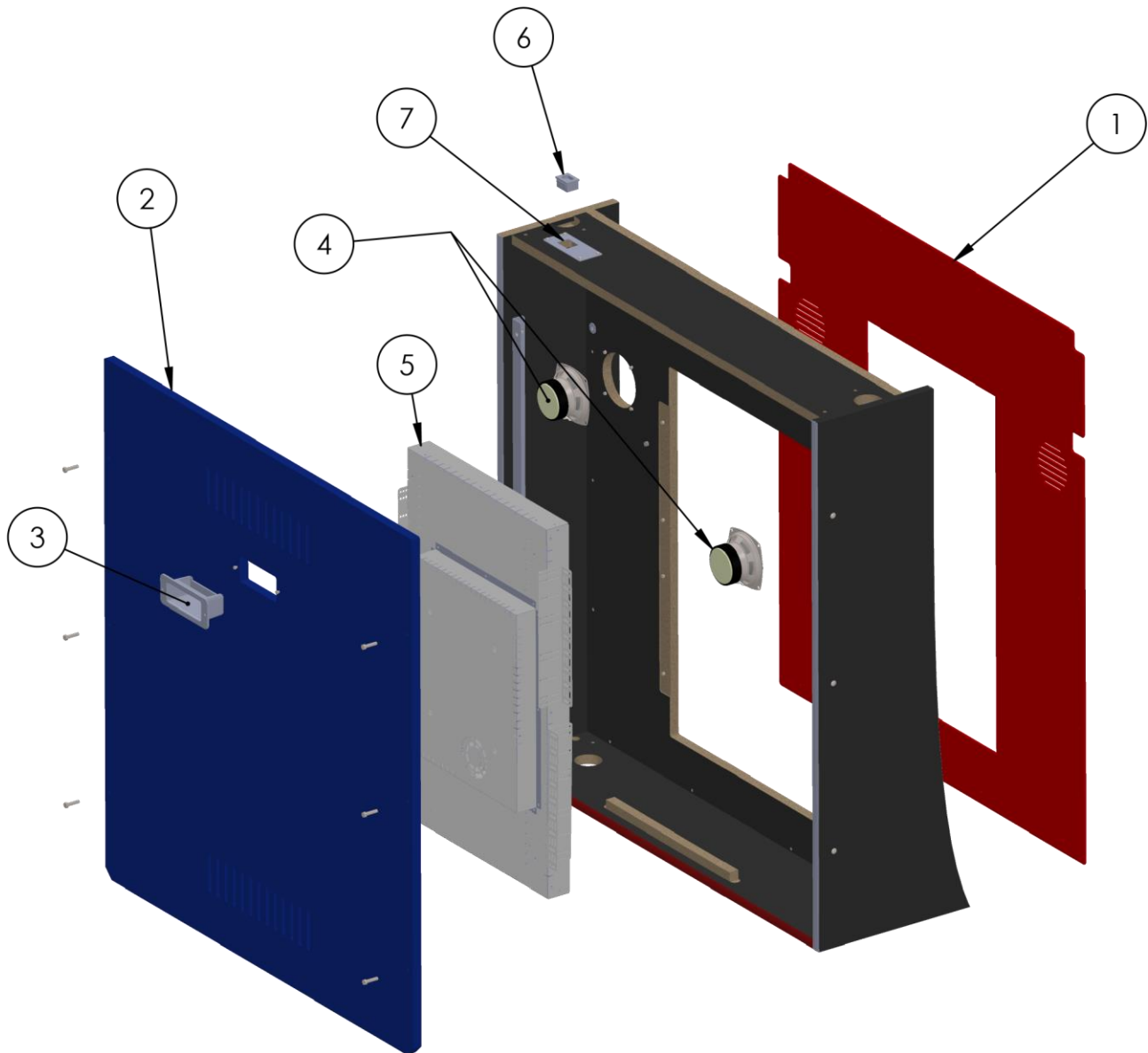

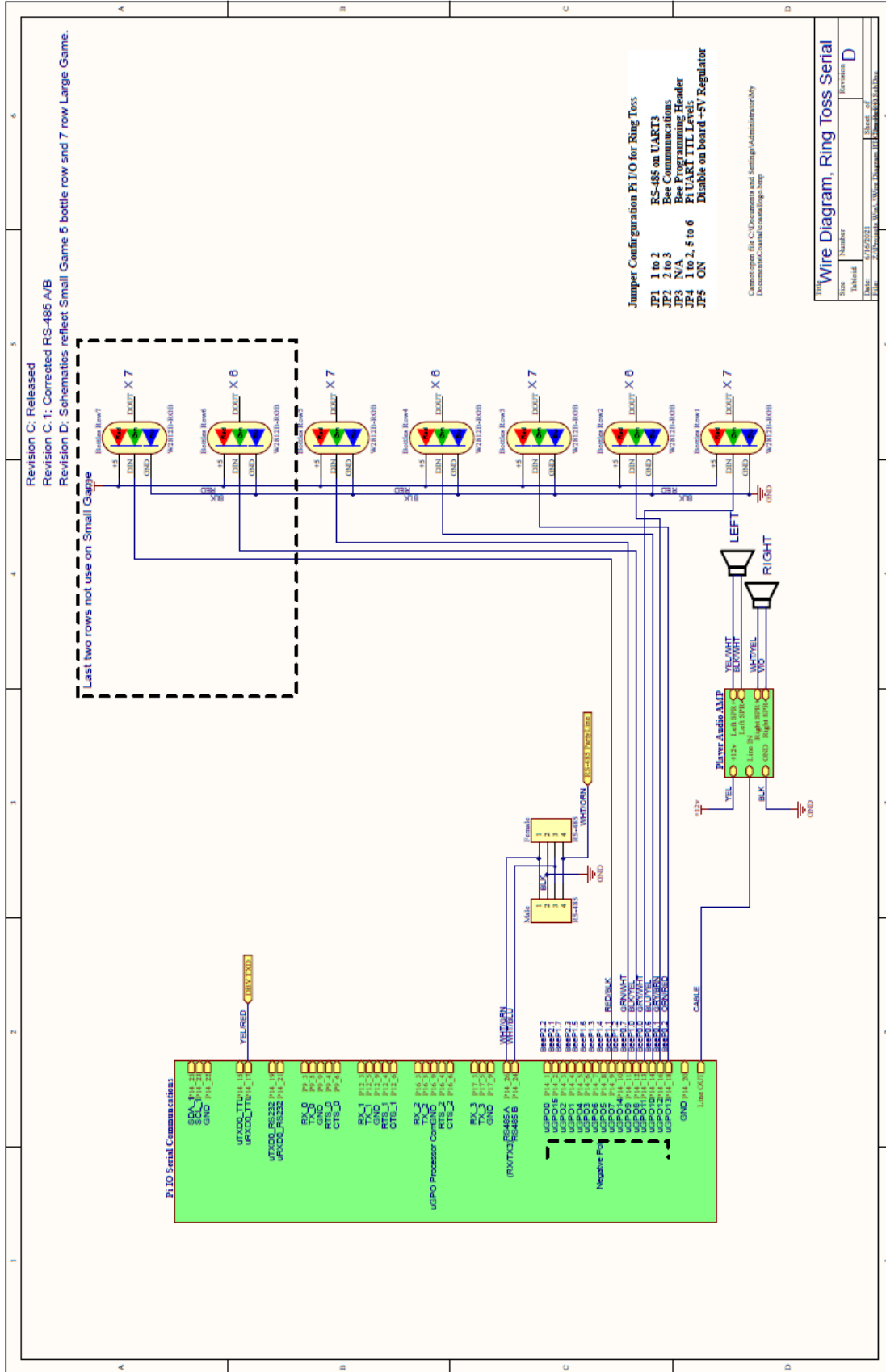

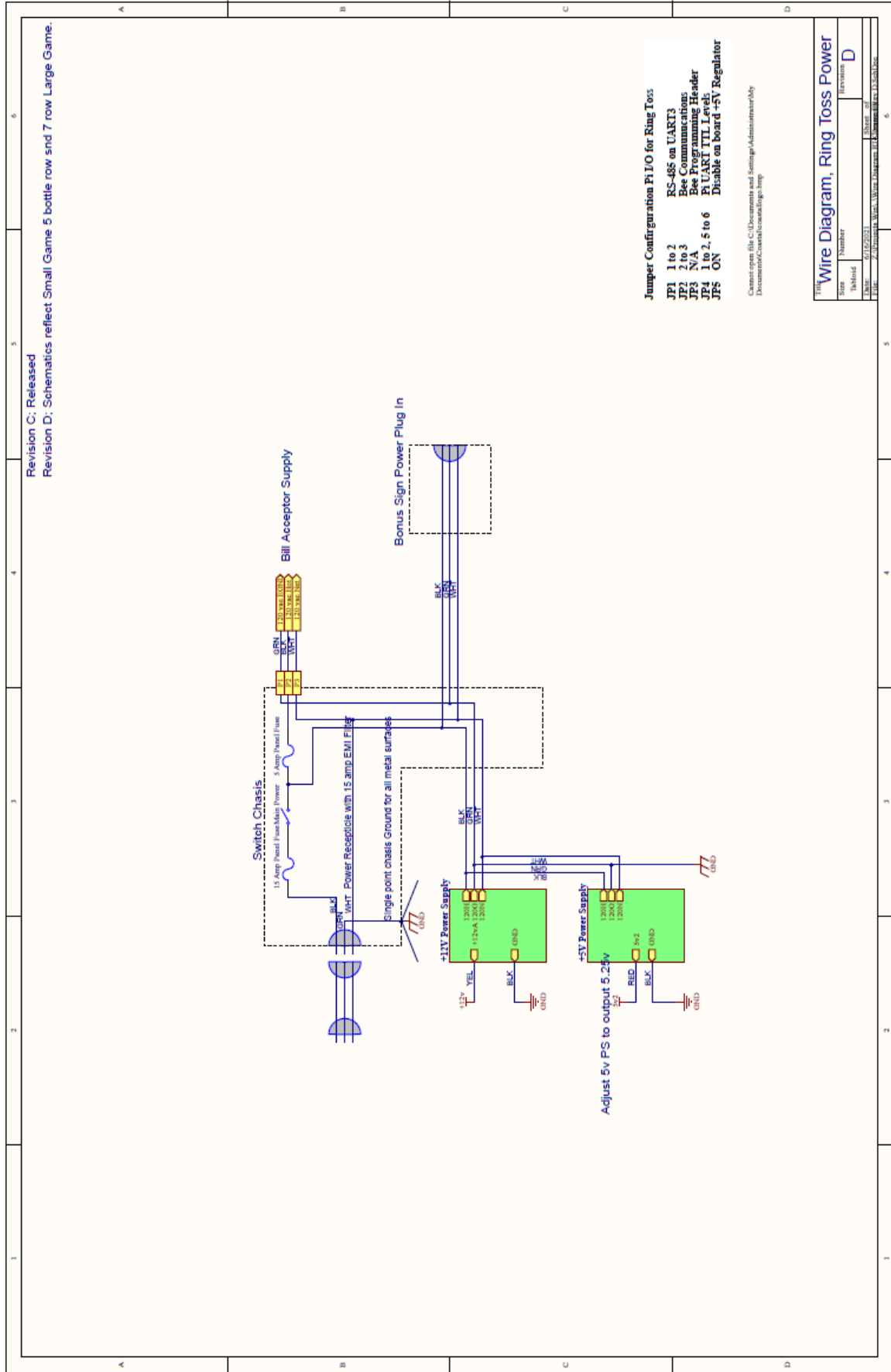

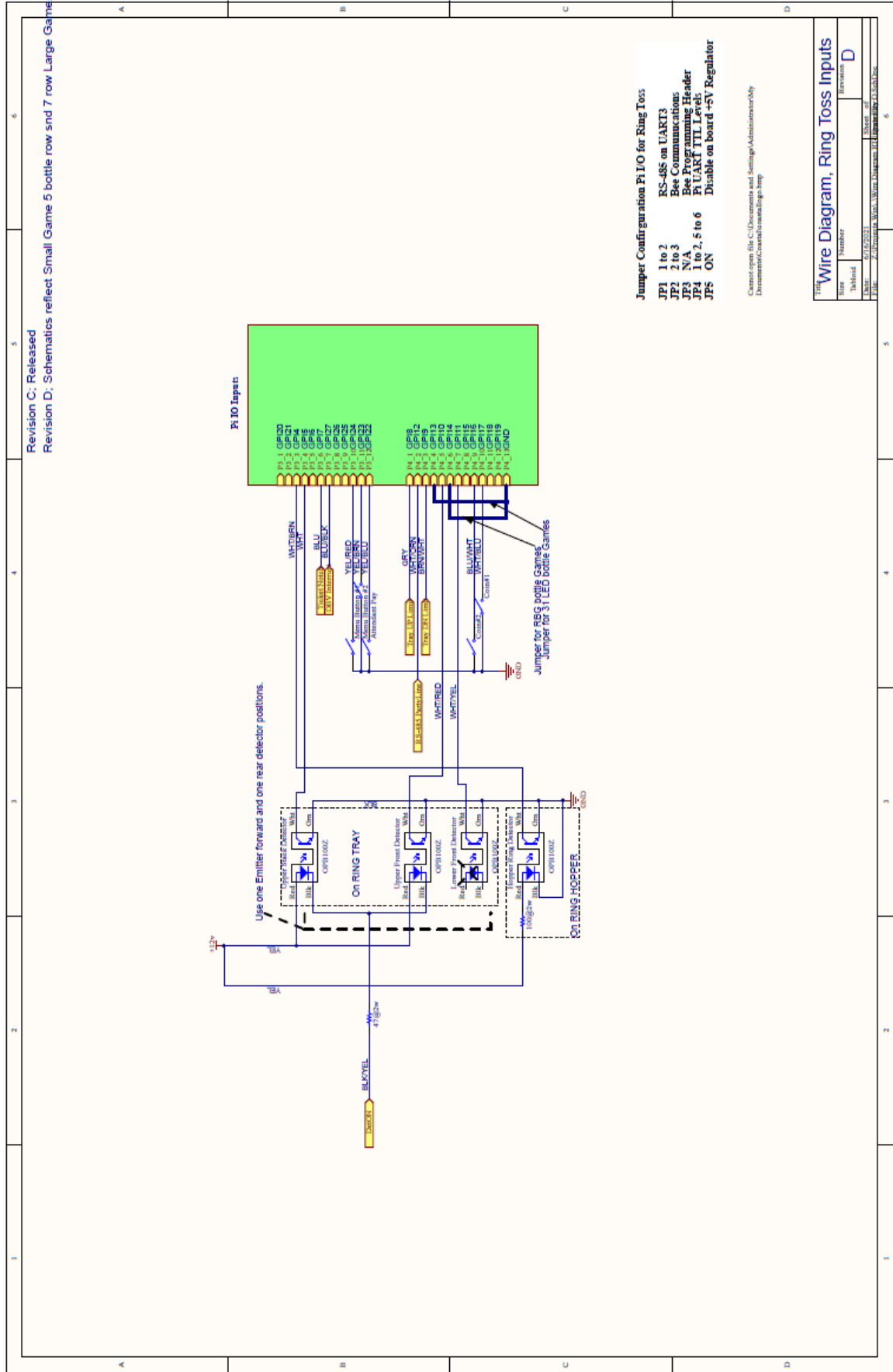

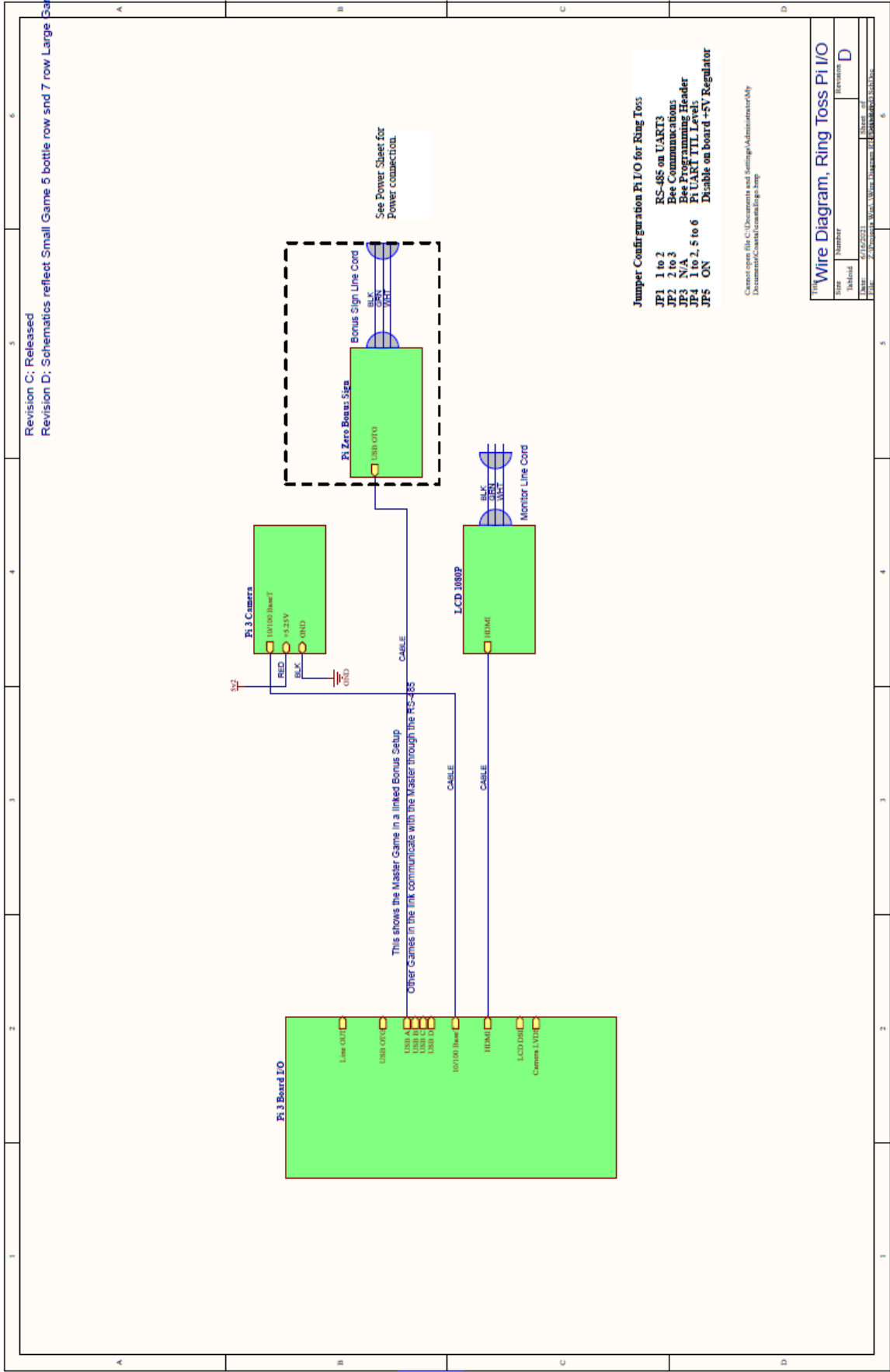

FACTORY WARRANTY

Coastal Amusements, Inc. warranties all parts and components in new games. All parts and components are warranted against material defects and workmanship as follows:

- Proprietary Electronic Hardware: 180 days
- Monitors: 180 days
- Other (non-proprietary) Electronic Hardware: 90 days
- Mechanical Components and Motors: 90 days

Coastal Amusements, Inc. will not be responsible to furnish parts, components or service under warranty if:

- Game components or parts have failed through normal wear and tear.
- Game components or parts have failed because of abuse or abnormal operation.
- Game components or parts have failed do to damage caused by improper service, or service performed by unqualified or unauthorized personnel.
- Game components or parts have failed do to arbitrary or unauthorized modification.

Certain procedures must be followed to ensure the game parts and components are covered under warranty and that proper credit is issued for returned parts and components as follows.

- Customer must provide a valid serial number for the game to be serviced.
- An RMA number must be obtained from our customer service staff for all warranty parts.
- The RMA number must appear on the return shipping carton in order to ensure proper credit.
- Coastal will replace the defective parts with new or factory reconditioned parts.
- Defective parts covered under warranty must be returned within 30 days.
- Defective parts returned after 30 days and before 60 days will incur a 25% restocking charge.
- Defective parts returned after 60 days will receive no credit.



1950 Swarthmore Ave. Lakewood, NJ 08701

Phone: +1-732-905-6662

sales@coastalamusements.com

www.coastalamusements.com